



TPOne-B

Electronic Programmable Room Thermostat



TPOne is an intelligent programmable heating control made easy. TPOne includes features which are designed to save energy. Look out for the leaf symbol throughout this guide for settings which can directly influence the energy saved.

This product complies with the following EU Directives:
Electromagnetic Compatibility
2014/30/EU
Low Voltage
2014/35/EU
Restriction of the use of certain Hazardous Substances
(2011/65/EU)



Danfoss can accept no responsibility for possible errors in catalogues, brochures, and other printed material. All trademarks in this material are property of the respective companies. Danfoss and the Danfoss logotype are trademarks of Danfoss A/S. All rights reserved.

Installation Instructions

Specifications	TPOne-B
Operating Voltage	2.5 - 3VDC (2x AA batteries)
Output relay	Volt Free
Setting temperature range	5-35°C
Operating temperature range	0-45°C
Switch rating	3A (1) at 230Vac
Switch type	1 x SPDT Type 1B
Battery lifetime	Min. 2 years
IP rating	IP20
On/off control	Yes
Chrono-proportional control	Yes
Operating mode	Heating
Construction	EN 60730-2-9
Control pollution situation	Degree 2
Rated impulse voltage	2.5kV
Ball pressure test	75°C
Dimensions (mm)	H67 x W154 x D30
Software Classification	A

ErP Class		
<p>The products represented within this document are classified according to, and allow completion of, the Energy Related Product (ErP) Directive System Package fiche and the ErP system data label. ErP Labelling obligation is applicable from 26th September 2015.</p>		
ERP Class	Product Function and ErP Description	Additional efficiency gain
IV 	<p>TPI Room Thermostat, for use with on/off output heaters</p> <p>An electronic room thermostat that controls both thermostat cycle rate and in-cycle on/off ratio of the heater proportional to room temperature. TPI control strategy reduces mean water temperature, improves room temperature control accuracy and enhances system efficiency.</p>	<p>2%</p>

Mounting

Thermostat or Remote Room Sensor positioning:

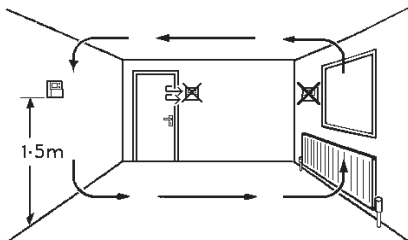

Please note: This product should only be installed by a qualified electrician or competent heating installer and should be in accordance with the local wiring regulations.

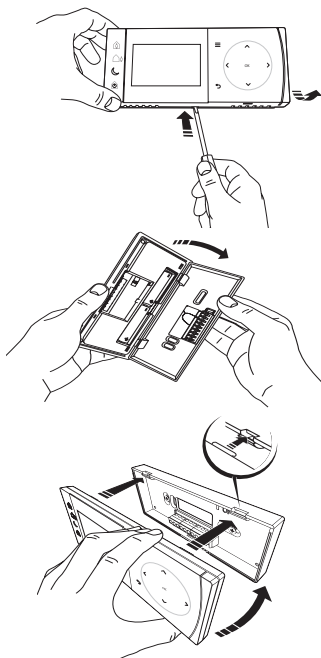

Wiring

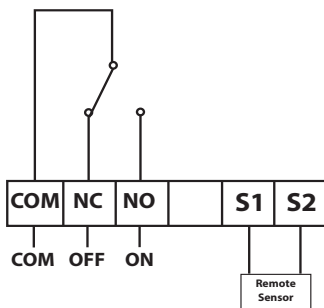

* Domestic hot water, optional timed output only

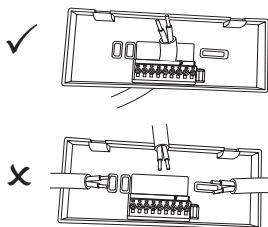

Remote sensor inputs

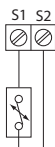

Remote room or limit sensor

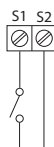

Window switch contact

NOTE:

Remote Sensor to be wired with 1mm 2 core double insulated cable only. Cable length should not exceed 10 metres. Sensor cable should NOT be run parallel to mains cable.

User Interface

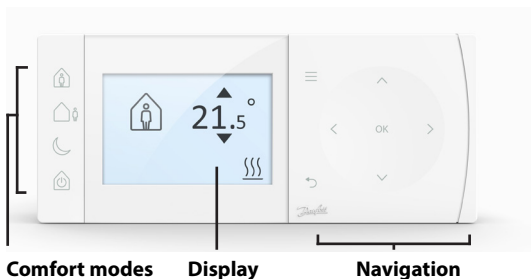

Comfort Modes

Heating made easy: TPOne Comfort Modes simplify the way you plan your heating day to day. You define your comfort modes in the user schedule and manually override when you need, allowing you to adapt your schedule to the way you live.





The Home, Away and Asleep comfort modes are linked to your defined comfort temperatures. The schedule follows the daily routine you have set or you just choose the comfort mode required and TPOne will recall the settings you have defined.

The TPOne Standby Mode allows you to switch your heating off when not required although the thermostat continues to monitor the room temperature and call for heating should there be a risk of frost damage.





NOTE:

TPOne has been designed with touch sensitive user interface buttons. To avoid accidental setting changes the interface buttons stay in an idle state during which time the first button press needs to be made for 1sec, this will place the TPOne into an active setting state. While active the TPOne will respond immediately to any valid key press. If no key presses are made for 30secs the buttons will go back to an idle state.

Comfort Modes



	<p>Home Mode selects the home comfort temperature typically when the home is occupied during the day. The required temperatures for Home mode are selectable in the Temperature setting (see User Menu > Temperatures.) A separate Home AM and Home PM temperature can be chosen and these are automatically set according to the time of the day.</p> <p><i>Note: When in Home mode if the home button is pressed again a 1, 2 or 3 hour heating boost is selected and the current home period is extended by the chosen time period. The chosen boost period is displayed under the Home icon on the display.</i></p>
	<p>Away Mode selects the away comfort temperature typically when the home is unoccupied during the day. The required temperature for Away mode is selectable in the Temperature setting (see User Menu > Temperatures).</p>
	<p>Asleep Mode selects the nighttime comfort temperature which is set between the end of the last home period of the day and the beginning of the first home period of the following day. The required temperature for Asleep mode is selectable in the Temperature setting (see User Menu > Temperatures).</p>
	<p>The TPOne can be placed in Standby Mode. While in Standby the TPOne will not control the heating system other than to protect against frost damage (see User Menu > Installer Settings > Frost Protect for information on frost protect). Standby can be cancelled by pressing the Standby button again or by selecting another comfort mode.</p> <p><i>Note: the standby option places the heating control in standby only, if Hot Water is set up this is not affected. To switch Hot Water control off see User Menu > Hot Water > Mode</i></p>

Navigation

	<p>Press Menu to access the intuitive text menu. The common feature User Menu will be displayed first. Additional settings can found in the User Setting option and more advance settings can be found in the Installer Setting option.</p>
	<p>Press OK to select menu options or confirm settings. OK will be shown on the display when it can be used or is required.</p>
	<p>Press ↶ to exit a menu option. Pressing ↶ while in a setting will result in that setting change not be accepted. ↶ will also exit the menu system. ↶ will be shown on the display when it can be used</p>
	<p>The Navigation buttons are used to navigate the TPOne menus and change setting values. The up & down buttons are also used to manually change the required temperature. Navigation arrows will be shown on the display when these buttons can be used.</p>

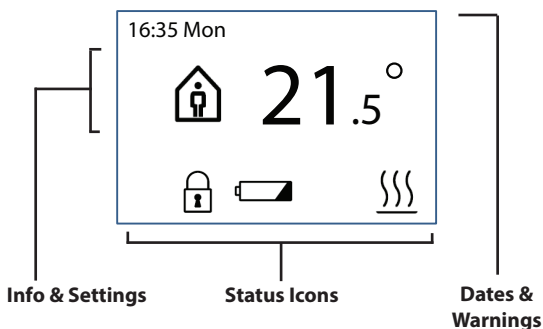
Display



	Button Lock	Indicates that Button Lock has been activated to avoid unintentional setting changes. To activate buttons while button lock is active press the OK button for 5 seconds. The Button Lock setting is found in the Installer Menu.
	Battery Low	The battery low icon indicates when the TPOne batteries should be changed. To avoid loss of heating or damage to your thermostat replace batteries when this icon is displayed.
	Heat Calling	When the current room temperature is below the required room set temperature the TPOne will call for heating from the connected heat source. This is indicated by the Heat Calling icon.

NOTE:

TPOne monitors several conditions and will provide warning or information messages when necessary. Details on these can be found on pages 24 - 26.

Setup Wizard

The setup wizard will run when power is first applied to the TPOne. Once set the further changes can be made in the user and installer setting menus.

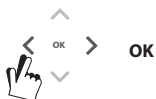

READY

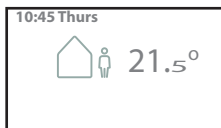
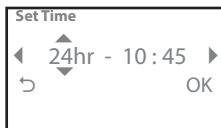
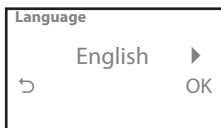

Set Temperatures

Follow this routine to set required Comfort Mode temperatures. Changes can be made for each mode, once all changes have been made press OK and a confirmation screen will display the new settings.

See page 22 for default temperatures

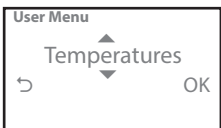
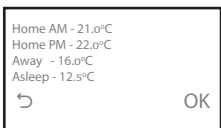
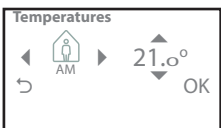
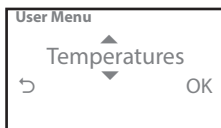
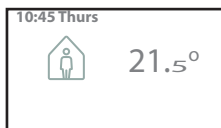

Setup Schedule

Follow this routine to set Heating Schedule. Days can be set individually or grouped and options for weekdays and weekend settings can be selected. All day combinations can then have one, two or three Home Periods selected. TPOne will automatically fill in the gaps with Away and Asleep Periods depending on the time of the day.

See page 22 for default schedule times

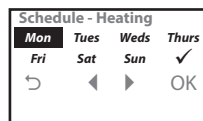
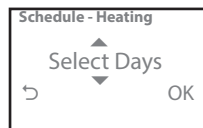
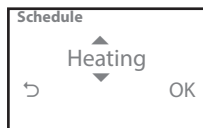
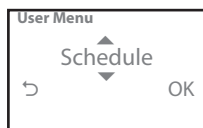
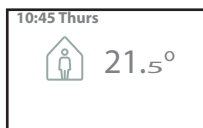

Setup Schedule (Continued)

OK OK

Schedule - Heating			
Mon	Tues	Weds	Thurs
Fri	Sat	Sun	✓
↶	◀	▶	OK

⤴ **OK** ⤵ **OK**
⤴ **OK** ⤵ **OK**

Select Home Periods		
◀	3	▶
↶		OK

⤴ **OK** ⤵ **OK** ⤴ **OK** ⤵

Home Period - 1	
From	To
◀06.00▶	◀08.30▶
↶	OK

⤴ **OK** ⤵ **OK** ⤴ **OK** ⤵

Home Period - 2	
From	To
◀12.30▶	◀13.30▶
↶	OK

⤴ **OK** ⤵ **OK** ⤴ **OK** ⤵ **OK**

Home Period - 3	
From	To
◀17.30▶	◀22.30▶
↶	OK



Schedule - Heating
Your heating schedule has been saved

⤴ **OK** ⤵ **OK** ↶

User Menu
Schedule
↶ OK

User Menu

Click & Save



Click & Save is an easy access saving function. Switching Click & Save ON will reduce the user set comfort temperatures by 1°C. Switching Click & Save OFF will return TPOne to the user set comfort temperatures.

Default setting: Off

Note: Independent tests have proven that a reduction in home heating temperatures by 1oC can save on average 10% energy.

Heating Mode

Heating Mode will change the TPOne from a thermostat with full user set heating schedule to a manually set temperature only thermostat. In schedule mode the thermostat will follow the user set heating schedule. In manual mode the user set schedule will be ignored, the required comfort mode is then chosen manually.

Default setting: Scheduled

Schedule



User set heating schedule option:

Heating - settings for the daily heating schedule. Choose weekday, weekend or independent daily options and 1,2 or 3 periods per day. Option to reset daily heating schedule to factory defaults.

Summary - graphical overview of the set daily heating or hot water schedule

Default settings: see default heating times later in this guide



User Menu (Continued)

Tempertures	<p>User set comfort temperatures (heating), individual comfort temperatures for Home AM, Home PM, Away and Asleep. Home AM and Home PM temperatures will be set during the home periods chosen in the user set heating schedule, see User Menu > Schedule. Away temperature will be set during the day between the home periods. Asleep temperature will be set during the night between the home periods.</p> <p>Default settings: Home AM - 20°C Home PM - 20°C Away - 15°C Asleep - 15°C</p>
Holiday 	<p>Holiday feature allows you to set in advance your holiday dates. TPOne will reduce the heating to your chosen Holiday temperature on the first day set to save energy and will return to your set schedule and mode temperatures on the return date to ensure the home is comfortable for your return.</p> <p>Enter start and end date of your holiday and the required energy saving home temperature.</p>

User Settings

Set Date	<p>Option to set the current date.</p> <p><i>Note: if batteries are removed or have expired for more than 2mins a startup wizard will prompt for date to be reset.</i></p>
Set Time	<p>Option to set the current time and 12 or 24hr clock setting.</p> <p><i>Note: if batteries are removed or have expired for more than 2mins a startup wizard will prompt for time to be reset.</i></p>
Button Click	<p>Button Click is an audible feedback feature to confirm button press. Button Click can be switched On or Off</p> <p>Default setting: On</p>
Backlight 	<p>When buttons are pressed on the TPOne the display backlight will come on to aid viewing. Where backlight is not required this feature can be switched off. Switching the backlight off will increase battery life.</p> <p>Default setting: On</p>
Temperature Scale	<p>Choose between centigrade °C or fahrenheit °F</p> <p>Default setting: °C</p>
Language	<p>Choose menu language</p> <p>Default: English</p> <p><i>Note: if required a reset menu language feature is available, press and hold OK for 5secs and the option to change language will be given.</i></p>
User Reset	<p>User Reset will return user settings only to the TPOne factory default.</p> <p><i>Note: User Reset will not reset settings in user menu or the date and time.</i></p>
Information	<p>Information on product type, software level and boiler service interval date if set.</p>

Installer Settings

Control Type 	<p>This allows the thermostat to be set to run in On/Off mode or in chrono-proportional 3, 6 or 12 cycle rate.</p> <p>Default: Chrono 6</p> <p><i>Note: for condensing boiler control tests have shown that boiler efficiency is significantly improved when controlled by a chrono-proportional type controller</i></p>
Start-up Method 	<p>This feature allows the thermostat to start up the heating system in three different ways.</p> <p>Normal - Heating is turned up or down at the programmed times.</p> <p>Delayed start (or Economy Setting) - Set the period start times in the normal way taking into account the time that the building takes to heat on an average day. The thermostat monitors switch on time, actual temperature and wanted temperature and delays the start of the heating if the actual temperature is close to the programmed temperature. Delayed Start in TPOne is dynamic and will adjust automatically to the home heating characteristics while maximising energy savings.</p> <p>Optimised Start (or Comfort Setting) - This allows you to programme the time at which you would like to be up to the required temperature. The thermostat then calculates how soon before the required time the heating is turned up. Optimised Start in TPOne is dynamic and will adjust automatically to the home heating characteristics to reach required temperature at the required time.</p> <p>Default: Normal</p>
Temperature Limits	<p>This allows the upper and lower temperature of the thermostat setting range to be limited.</p> <p>Defaults: Minimum 5°C, Maximum 35°C</p>

Installer Settings (Continued)

Frost Protect	<p>To help protect against damage to the heating system caused by extreme low temperatures the TPOne includes a Frost Protect level. This is the minimum temperature level and is also used when the TPOne is placed in standby mode.</p> <p>Default: 5°C</p>
Temperature Override	<p>This establishes the degree of manual temperature override available to the user, No Limit, Limited +/- 2°C or No Override</p> <p>Default: No Limit</p>
Daylight Saving	<p>Choose to set automatic daylight saving changes on or off.</p> <p>Default: On</p>
Button Lock	<p>Button lock can be set to avoid unintentional setting changes. To activate buttons while button lock is active the user must press the OK button for 5 seconds.</p> <p>Default: Off</p>
Display Idle Mode 	<p>When the TPOne is in idle mode the display can be set to go off. The display will come on when any button is pressed.</p> <p>Default: On</p>

Installer Settings (Continued)

External Sensor



TPOne includes an optional external sensor input. If fitted select the type of external sensor:

None - No external sensor fitted

Room Sensor - Remote room sensor fitted. This will take priority over the TPOne internal sensing.
Danfoss part TS2A - sold seperately

Window Sensor - Where a window sensor has been fitted the TPOne will go into standby mode while the window is open. Window open feature is activated 60secs after input is made open circuit. Window open feature is deactivated 30secs after input is made closed circuit.

Floor Limit Sensor - This allows for a thermostat limit sensor to be set, typical application is floor heating. If the temperature sensed by the limit sensor exceeds the limit setting the output will be turned off until the temperature has dropped by 2°C. A warning will be shown on the display that the floor limit temperature has been exceeded. Room temperature will be controlled by the TPOne internal sensor.

The temperature set for the limit point sensor will be determined by the type of floor.

The recommended limits are:

Tiles on chipboard and wooden floors 27°C

Carpet or vinyl on chipboard 35°C

Tiles on concrete floor 40°C

Concrete, screed, etc 45°C

Danfoss Part TS3 - sold seperately

Lockout - Where a Key lockout switch is fitted the TPOne can be forced into the standby mode remotely. While activated none of the buttons can be used and the TPOne will only call for heat if room temperature falls below set frost protect level. Lockout feature is activated 60secs after input is made open circuit. Feature is deactivated 30secs after input is made closed circuit.

Installer Settings (Continued)

Service Interval	<p>TPOne incorporates a service interval timer where a service due date for the boiler can be set. The service interval timer is passcode protected and must only be set by a qualified heating installation engineer. The installer can set the service due date and select from one of four service due restriction modes:</p> <p>1 - Warning Only - visual and audible warnings only, no reduction of heat. 2 - Heat 45min/hr - visual and audible warnings with reduction of heat to 45 minutes per hour. 3 - Heat 30min/hr - visual and audible warnings with reduction of heat to 30 minutes per hour. 4 - Heat 15min/hr - visual and audible warnings with reduction of heat to 15 minutes per hour. 5 - No Heating - visual and audible warnings with no heating.</p> <p>Once set, the service interval timer can only be reset or deactivated by an installer having the correct access code. Additional information on Service Interval can be found later in this guide</p> <p><i>Note: If the TPOne is fitted to a combination boiler, the function only works in conjunction with a heating demand, hot water production is unaffected.</i></p>
Service Demo	Choose this feature to provide a demonstration of the audible and visual warning which will be given when service is due.
Installer Lock	TPOne allows the installer to lock all installer settings by means of a passcode. The 3 digit passcode can be chosen and set by the installer and once set will be required to make any installer setting changes.
Installer Reset	Select option to reset all installer settings to factory defaults.

Note: Service interval will not be reset and can only be reset or deactivated by entering the service interval setup.

Service Interval

If the property is owned by a landlord he may, for gas safety reasons, have instructed the installer to set the service interval timer. The feature is primarily aimed at the rented property sector where the Landlord has a legal responsibility under gas safety regulations* to ensure that the boiler is serviced every year.

- If set, 28 days prior to the service due date, an audible warning will start each day at noon, the service icon will also be displayed. The audible warning will last for 10 seconds and will be repeated every hour until a button is pressed to cancel it. If cancelled the alarm will recommence the following day at noon.

- If the boiler is not serviced before the due date, an audible warning will start each day at noon, the service icon will also be displayed. The audible warning will last for 1 minute and will be repeated every hour until a button is pressed to cancel it. If cancelled the alarm will recommence the following day at noon.

- In addition, all overrides and programming buttons will be disabled and the Heating and Hot Water may operate for a limited amount of time each hour.

















- The installer may cancel or reset the service interval timer as part of the boiler service.

- This is a gas safety feature that can only be accessed by a qualified heating installation engineer.

**Gas Safety Regulations may vary according to region*





Default tables

SCHEDULE DEFAULTS

1	2	3
		
 06:30 - 22:30 (Weekend 07:30 - 22:30)	 06:30 - 08:30 (Weekend 07:30 - 09:30)	 06:30 - 08:30 (Weekend 07:30 - 09:30)
		
	 16:30 - 22:30	 11:30 - 13:30
		
		 16:30 - 22:30
		

Default tables (Continued)

TEMPERTURE DEFAULTS

 AM	20°C
 PM	20°C
	15°C
	15°C

Information

TPOne will show information related to current operation, these messages will be shown at the top of the display. Information messages will be displayed while the operation is active and will automatically reset when operation is completed

Window Open	This will be displayed where a window open switch has been fitted and the window is opened. <i>see page 19</i>
Product Lock	This will be displayed where a product lock switch has been fitted and the switch has been activated. <i>see page 19</i>
Optimised Start	If the TPOne start up method is set to Optimised Start this message will display while this feature is active. <i>see page 18</i>
Delayed Start	If the TPOne start up method is set to Delayed Start this message will display while this feature is active. <i>see page 18</i>

Warnings

TPOne monitors several conditions and will provide warnings when necessary, these messages will be shown at the top of the display. If the condition that has created the warning has been corrected then the message can be cancelled by selecting Clear Warnings in the TPOne menu. Where more than one warning has occurred the most recent will be shown on the display. All warnings can be viewed and cleared in the Clear Warnings menu.

Frost Risk	This will be displayed if the TPOne monitors a temperature of below 5°C. TPOne will call for heat if this occurs but if the heat source is faulty then risk of frost damage may still occur. The heating system should be checked to confirm it is operating correctly
Low Heat	If set mode temperature is not reached within 2 hours then TPOne will warn of Low Heat. The heating system should be checked to confirm it is operating correctly
Service Due	Where the TPOne Service Interval timer has been set this warning will be shown when the timer has expired. Contact the property owner or landlord to arrange the boiler safety maintenance. <i>see page 21</i>
Heat Reduced	Where the TPOne Service Interval timer has been set this warning will show after the timer has expired and will indicate that heating has been reduced for your safety until a boiler service has been completed. Contact the property owner or landlord to arrange the boiler safety maintenance. <i>see page 21</i>
High Floor Temperature	Where a floor limit temperature sensor has been fitted if the floor temperature exceeds the set limit this warning will show. If the floor temperature has reduced to a safe level the TPOne will continue to control heating but the reason for the overheat may still exist. The floor heating system should be checked to ensure overheating does not reoccur.

Warnings (continued)

Sensor Fail	If the TPOne in-built temperature sensor is measuring outside it's operational parameters then it may have failed. If this warning cannot be reset then contact your service provider for advice.
External Sensor Fail	If an external temperature sensor has been fitted and the TPOne is measuring outside it's operational parameters then it may indicate a problem with the external sensor or connecting cable. If this warning cannot be reset then contact your service provider for advice.
Floor Sensor Fail	If a floor temperature sensor has been fitted and the TPOne is measuring outside it's operational parameters then it may indicate a problem with the floor sensor or connecting cable. If this warning cannot be reset then contact your service provider for advice.

ENGINEERING
TOMORROW



Danfoss Ltd.

Amphill Road
Bedford MK42 9ER

Tel: 01234 364621

Fax: 01234 219705

Email: ukheating@danfoss.com

Website: www.heating.danfoss.co.uk